

Plastové svěrné spojky a navrtávky Plas-Fit na vodu pro PE trubky 16 – 110 mm

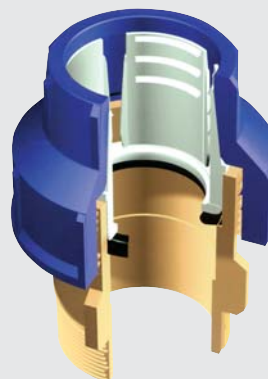





Certifikát:	ČR – ITC, a.s., AO č. 224 – č. 11 0039 h SR – VÚSAPL, a.s., AO č. SK06-ZSV-0241
Použití – trubky:	svěrné tvarovky Plas-Fit jsou určeny pro spojování trubek ze všech druhů polyetylenu (PEHD, PEMD, PELD) dle DIN 8074, ISO 4427
Použití – medium:	pitná voda – ČR – vyhláška MZd č. 409/2005 Sb. – SR – vyhláška MZ SR č. 550/2007 Z.z. jsou odolné mnoha běžným chemikáliím s výjimkou organických rozpouštědel a některých ropných produktů (nutno vždy konzultovat)
Tlak:	při teplotě do +20 °C řada 150 rozměr 16 – 63 mm – PN 16 75 – 160 mm – PN 10 řada 350 – Plas-Fit EASY SYSTÉM rozměr 75 – 110 mm – PN 16
Teplota:	-20 °C až +60 °C – vyšší teploty nutno konzultovat
Použitý materiál:	tělo spojky – BOREALIS BA160E-8229, černý těsnění – řada 150 – NBR pryž řada 350 – EPDM pryž, směs E701A/1, barva černá svěrný kroužek – POM, barva bílá tvarovky s vnitřním závitem nad 1" mají výztužný kovový kroužek
Ostatní:	spojky jsou určeny i pro použití do země (při použití v zemi dbejte pokynů výrobce trubek pro uložení v zemi) tělo spojky a převlečná matice jsou stabilizovány proti UV záření řada 150 tvar závitů vylučuje utažení přes závit a jeho uvolnění v důsledku vibrací při montáži do rozměru 75 mm se spojka nerozebírá řada 350 výhody trvalý pracovní tlak PN16 (nová konstrukce) při montáži je zapotřebí jen minimální síla při vsunutí trubky trubka snadno projde těsněním a je tak zajištěno, že trubka je dostatečně vsunuta trubka může být vsunuta bez ohranění montáž je tak snadná, rychlá a správná (bezchybná) nutno dbát na řádné dotažení klíčem těsnění je jako harmonika a při dotahování si „sedne“
Závity:	ISO 7
Záruka:	5 let
Označení výrobku:	



**GARANTOVANÁ ŽIVOTNOST 50 LET
PŘI DODRŽENÍ PROVOZNÍCH TLAKŮ**





Plastové svěrné spojky Plas-Fit



	Objednací číslo	Rozměr v mm	Bal. v ks	
	15016M0101	A 16 – 1/2"	100	
	15016M0102	A 16 – 3/4"	100	
	15020M0101	A 20 – 1/2"	140	
	15020M0102	A 20 – 3/4"	140	
	15020M0103	A 20 – 1"	130	
	15025M0101	A 25 – 1/2"	120	
	15025M0102	A 25 – 3/4"	100	
	15025M0103	A 25 – 1"	100	
	15032M0102	A 32 – 3/4"	80	
	15032M0103	A 32 – 1"	60	
	15032M0104	A 32 – 1 1/4"	60	
	15040M0103	A 40 – 1"	40	
	15040M0104	A 40 – 1 1/4"	36	
	15040M0105	A 40 – 1 1/2"	36	
	15040M0106	A 40 – 2"	30	
	15050M0105	A 50 – 1 1/2"	30	
	15050M0106	A 50 – 2"	30	
	15063M0105	A 63 – 1 1/2"	18	
	15063M0106	A 63 – 2"	18	
	15075M0106	A 75 – 2"	16	
	15075M0107	A 75 – 2 1/2"	16	
	15075M0108	A 75 – 3"	13	
	15090M0106	A 90 – 2"	6	
	15090M0108	A 90 – 3"	6	
	15110M0108	A 110 – 3"	4	
	15110M0114	A 110 – 4"	4	
		35075M0106	A 75 × 2"	16
		35075M0107	A 75 × 2 1/2"	16
35075M0108		A 75 × 3"	13	
35090M0106		A 90 × 2"	6	
35090M0107		A 90 × 2 1/2"	6	
35090M0108		A 90 × 3"	6	
35090M0114		A 90 × 4"	6	
35110M0106		A 110 × 2"	4	
35110M0108		A 110 × 3"	4	
35110M0114		A 110 × 4"	4	

	Objednací číslo	Rozměr v mm	Bal. v ks	
	15016M0201	I 16 – 1/2"	100	
	15016M0202	I 16 – 3/4"	85	
	15020M0201	I 20 – 1/2"	135	
	15020M0202	I 20 – 3/4"	115	
	15025M0202	I 25 – 3/4"	100	
	15025M0203	I 25 – 1"	100	
	15032M0202	I 32 – 3/4"	60	
	15032M0203	I 32 – 1"	60	
	15032M0204	I 32 – 1 1/4"	56	
	15040M0204	I 40 – 1 1/4"	36	
	15040M0205	I 40 – 1 1/2"	30	
	15050M0205	I 50 – 1 1/2"	30	
	15050M0206	I 50 – 2"	30	
	15063M0205	I 63 – 1 1/2"	18	
	15063M0206	I 63 – 2"	18	
	15075M0206	I 75 – 2"	13	
	15075M0207	I 75 – 2 1/2"	13	
	15090M0206	I 90 – 2"	6	
	15090M0208	I 90 – 3"	6	
	15110M0208	I 110 – 3"	4	
	15110M0214	I 110 – 4"	4	
		35075M0206	I 75 × 2"	13
		35075M0207	I 75 × 2 1/2"	12
		35075M0208	I 75 × 3"	6
		35090M0206	I 90 × 2"	6
		35090M0207	I 90 × 2 1/2"	6
		35090M0208	I 90 × 3"	6
		35090M0214	I 90 × 4"	6
35110M0208		I 110 × 3"	4	
35110M0214	I 110 × 4"	4		

	Objednací číslo	Rozměr v mm	Bal. v ks	
	Spojka přímá 15016M0016	O 16	75	
	15020M0020	O 20	90	
	15025M0025	O 25	60	
	15032M0032	O 32	36	
	15040M0040	O 40	36	
	15050M0050	O 50	18	
	15063M0063	O 63	11	
	15075M0075	O 75	8	
	15090M0090	O 90	3	
	15110M0110	O 110	2	
		35075M0075	O 75	8
		35090M0090	O 90	3
35110M0110		O 110	2	

	Objednací číslo	Rozměr v mm	Bal. v ks
	Spojka přímá opravná 15020K0020	OL 20	90
	15025K0025	OL 25	60
	15032K0032	OL 32	36
	15040K0040	OL 40	15
	15050K0050	OL 50	12
	15063K0063	OL 63	8
	15075K0075	OL 75	5
	15090K0090	OL 90	3
	15110K0110	OL 110	2
		35075K0075	OL 75
35090K0090		OL 90	2
35110K0110		OL 110	1

	Objednací číslo	Rozměr v mm	Bal. v ks	
	Koleno s vnějším závitem 15016Z0101	WA 16 – 1/2"	90	
	15016Z0102	WA 16 – 3/4"	90	
	15020Z0101	WA 20 – 1/2"	120	
	15020Z0102	WA 20 – 3/4"	100	
	15025Z0101	WA 25 – 1/2"	85	
	15025Z0102	WA 25 – 3/4"	75	
	15025Z0103	WA 25 – 1"	70	
	15032Z0102	WA 32 – 3/4"	50	
	15032Z0103	WA 32 – 1"	45	
	15040Z0104	WA 40 – 1 1/4"	40	
	15040Z0105	WA 40 – 1 1/2"	40	
	15040Z0106	WA 40 – 2"	36	
	15050Z0105	WA 50 – 1 1/2"	24	
	15050Z0106	WA 50 – 2"	20	
	15063Z0106	WA 63 – 2"	14	
	15075Z0106	WA 75 – 2"	9	
	15075Z0107	WA 75 – 2 1/2"	9	
	15075Z0108	WA 75 – 3"	8	
		35075Z0107	WA 75 × 2 1/2"	9
		35075Z0108	WA 75 × 3"	8
35090Z0108		WA 90 × 3"	4	
35110Z0114		WA 110 × 4"	2	

	Objednací číslo	Rozměr v mm	Bal. v ks	
	Spojka přímá redukováná 15020D0016	OR 20 – 16	50	
	15025D0016	OR 25 – 16	35	
	15025D0020	OR 25 – 20	70	
	15032D0020	OR 32 – 20	54	
	15032D0025	OR 32 – 25	48	
	15040D0025	OR 40 – 25	30	
	15040D0032	OR 40 – 32	22	
	15050D0025	OR 50 – 25	18	
	15050D0032	OR 50 – 32	25	
	15050D0040	OR 50 – 40	24	
	15063D0032	OR 63 – 32	15	
	15063D0040	OR 63 – 40	15	
	15063D0050	OR 63 – 50	12	
	15075D0032	OR 75 – 32	12	
	15075D0040	OR 75 – 40	12	
	15075D0050	OR 75 – 50	11	
	15075D0063	OR 75 – 63	8	
	15110D0090	OR 110 – 90	4	
		35075D0063	OR 75 × 63	8
		35090D0063	OR 90 × 63	6
		35090D0075	OR 90 × 75	6
		35110D0075	OR 110 × 75	4
		35110D0090	OR 110 × 90	4



	Objednací číslo	Rozměr v mm	Bal. v ks	
	Koleno s vnitřním závitem 15016Z0201	WI 16 – 1/2"	90	
	15016Z0202	WI 16 – 3/4"	75	
	15020Z0201	WI 20 – 1/2"	100	
	15020Z0202	WI 20 – 3/4"	100	
	15025Z0202	WI 25 – 3/4"	65	
	15025Z0203	WI 25 – 1"	60	
	15032Z0202	WI 32 – 3/4"	45	
	15032Z0203	WI 32 – 1"	40	
	15032Z0204	WI 32 – 1 1/4"	35	
	15040Z0204	WI 40 – 1 1/4"	36	
	15040Z0205	WI 40 – 1 1/2"	36	
	15050Z0204	WI 50 – 1 1/4"	20	
	15050Z0205	WI 50 – 1 1/2"	20	
	15050Z0206	WI 50 – 2"	20	
	15063Z0205	WI 63 – 1 1/2"	14	
	15063Z0206	WI 63 – 2"	12	
	15075Z0206	WI 75 – 2"	9	
	15075Z0207	WI 75 – 2 1/2"	8	
	15075Z0208	WI 75 – 3"	8	
		35075Z0207	WI 75 × 2 1/2"	8
		35075Z0208	WI 75 × 3"	8
		35090Z0208	WI 90 × 3"	4
		35110Z0214	WI 110 × 4"	2



	Objednací číslo	Rozměr v mm	Bal. v ks
	15016Z0016	WO 16	70
	15020Z0020	WO 20	70
	15025Z0025	WO 25	45
	15032Z0032	WO 32	30
	15040Z0040	WO 40	28
	15050Z0050	WO 50	14
	15063Z0063	WO 63	8
	15075Z0075	WO 75	6
	35075Z0075	WO 75	6
	35090Z0090	WO 90	4
	35110Z0110	WO 110	2



	Objednací číslo	Rozměr v mm	Bal. v ks
	15025Z0020	WO 25 × 20	45



	15020Z8201	20 × 1/2" × 20	30
	15025Z8201	25 × 1/2" × 25	45



	15020Y0102	WI 20 – 3/4" – 20	
---	------------	-------------------	--

	15016T0101	TA 16 – 1/2"	50
	15016T0102	TA 16 – 3/4"	50
	15020T0101	TA 20 – 1/2"	60
	15020T0102	TA 20 – 3/4"	60
	15025T0101	TA 25 – 1/2"	40
	15025T0102	TA 25 – 3/4"	40
	15025T0103	TA 25 – 1"	40
	15032T0102	TA 32 – 3/4"	40
	15032T0103	TA 32 – 1"	40
	15040T0102	TA 40 – 3/4"	22
	15040T0104	TA 40 – 1 1/4"	22
	15040T0105	TA 40 – 1 1/2"	22
	15040T0106	TA 40 – 2"	22
	15050T0102	TA 50 – 3/4"	12
	15050T0104	TA 50 – 1 1/4"	12
	15050T0105	TA 50 – 1 1/2"	12
	15050T0106	TA 50 – 2"	11
	15063T0105	TA 63 – 1 1/2"	8
	15063T0106	TA 63 – 2"	8
	15075T0106	TA 75 – 2"	5
15075T0107	TA 75 – 2 1/2"	4	
15075T0108	TA 75 – 3"	4	
	35075T0107	TA 75 × 2 1/2"	4
	35075T0108	TA 75 × 3"	4
	35090T0108	TA 90 × 3"	2
	35110T0114	TA 110 × 4"	1

	15016T0201	TI 16 – 1/2"	50
	15016T0202	TI 16 – 3/4"	45
	15020T0201	TI 20 – 1/2"	60
	15020T0202	TI 20 – 3/4"	60
	15025T0201	TI 25 – 1/2"	40
	15025T0202	TI 25 – 3/4"	40
	15025T0203	TI 25 – 1"	40
	15032T0202	TI 32 – 3/4"	40
	15032T0203	TI 32 – 1"	36
	15032T0204	TI 32 – 1 1/4"	36
	15040T0203	TI 40 – 1"	22
	15040T0204	TI 40 – 1 1/4"	22
	15040T0205	TI 40 – 1 1/2"	20
	15050T0204	TI 50 – 1 1/4"	11
	15050T0205	TI 50 – 1 1/2"	11
	15050T0206	TI 50 – 2"	11
	15063T0205	TI 63 – 1 1/2"	8
	15063T0206	TI 63 – 2"	8
	15075T0206	TI 75 – 2"	4
	15075T0207	TI 75 – 2 1/2"	4
15075T0208	TI 75 – 3"	4	
	35075T0207	TI 75 × 2 1/2"	4
	35075T0208	TI 75 × 3"	4
	35090T0208	TI 90 × 3"	2
	35110T0214	TI 110 × 4"	1



	Objednací číslo	Rozměr v mm	Bal. v ks
	15016T0016	T 16	40
	15020T0020	T 20	48
	15025T0025	T 25	30
	15032T0032	T 32	30
	15040T0040	T 40	18
	15050T0050	T 50	8
	15063T0063	T 63	6
	15075T0075	T 75	3
 	35075T0075	T 75	3
	35090T0090	T 90	2
	35110T0110	T 110	1

	Objednací číslo	Rozměr v mm	Bal. v ks
	15020T0016	TR 20 – 16	25
	15025T0016	TR 25 – 16	40
	15025T0020	TR 25 – 20	33
	15032T0016	TR 32 – 16	33
	15032T0025	TR 32 – 25	33
	15040T0032	TR 40 – 32	18
	15050T0040	TR 50 – 40	9
	15063T0050	TR 63 – 50	6
	15075T0063	TR 75 – 63	4
	 	35075T0063	TR 75 × 63
35090T0075		TR 90 × 75	2
35110T0090		TR 110 × 90	1

Zátka svěrná	Objednací číslo	Zátka	Bal. v ks
	15020S0120	Zátka 20	150
	15025S0120	Zátka 25	100
	15032S0120	Zátka 32	72
	15040S0120	Zátka 40	40
	15050S0120	Zátka 50	30
	15063S0120	Zátka 63	20
	15075S0120	Zátka 75	14
	15090S0120	Zátka 90	6
 	15110S0120	Zátka 110	4
	35075S0075	Zátka 75	14
	35090S0090	Zátka 90	6
	35110S0110	Zátka 110	4

Montážní klíč kovový	Objednací číslo	Rozměr	Bal. v ks
	1504000005	40 – 75	30
	1506300005	40 – 110	20

Utahovací klíč z polymeru	Objednací číslo	Rozměr	Bal. v ks
	1502500006	16 – 40	30
	1504000006	40 – 75	30

Příruba	Objednací číslo	Rozměr	Bal. v ks
 	35075F0007	75 × 2 1/2" – DN 65	
	35075F0008	75 × 3" – DN 80	
	35090F0008	90 × 3" – DN 80	
	35090F0014	90 × 4" – DN 100	
	35110F0014	110 × 4" – DN 100	

Ořezávátka	Objednací číslo	Rozměr	Bal. v ks
	1506300000	Ořezávátka 16 – 63	60

Plastové navrtávky Plas-Fit

	Objednací číslo	Rozměr v mm	Bal. v ks
Navrtávka - 2 šrouby 	14025R0201	Navrtávka 25 × 1/2"	120
	14025R0202	Navrtávka 25 × 3/4"	120
	14032R0201	Navrtávka 32 × 1/2"	110
	14032R0202	Navrtávka 32 × 3/4"	110
	14040R0201	Navrtávka 40 × 1/2"	65
	14040R0202	Navrtávka 40 × 3/4"	65
	14040R0203	Navrtávka 40 × 1"	65
	14050R0201	Navrtávka 50 × 1/2"	65
	14050R0202	Navrtávka 50 × 3/4"	65
	14050R0203	Navrtávka 50 × 1"	65
	14063R0202	Navrtávka 63 × 3/4"	30
	14063R0203	Navrtávka 63 × 1"	30
	14075R0202	Navrtávka 75 × 3/4"	34
	14075R0203	Navrtávka 75 × 1"	34

	Objednací číslo	Rozměr v mm	Bal. v ks
Navrtávka - 4 šrouby 	14063R4201	Navrtávka 63 × 1/2"	30
	14063R4202	Navrtávka 63 × 3/4"	30
	14063R4203	Navrtávka 63 × 1"	30
	14063R4205	Navrtávka 63 × 1 1/2"	40
	14075R4202	Navrtávka 75 × 3/4"	30
	14075R4203	Navrtávka 75 × 1"	30
	14075R4205	Navrtávka 75 × 1 1/2"	30
	14090R4202	Navrtávka 90 × 3/4"	25
	14090R4203	Navrtávka 90 × 1"	25
	14090R4205	Navrtávka 90 × 1 1/2"	25
	14090R4206	Navrtávka 90 × 2"	25
	14110R4203	Navrtávka 110 × 1"	20
	14110R4205	Navrtávka 110 × 1 1/2"	20
	14110R4206	Navrtávka 110 × 2"	20

Navrtávka - 6 šroubů 	14140R6206	Navrtávka 140 × 2"	10
	14160R6203	Navrtávka 160 × 1"	10
	14160R6205	Navrtávka 160 × 1 1/2"	10
	14160R6206	Navrtávka 160 × 2"	10
	14160R6208	Navrtávka 160 × 3"	8

Navrtávky dodáváme také v novém designu
- objednací číslo začíná 24



Použitý materiál:	nerezový pant
Ostatní:	rychlá montáž

Navrtávka TAVOR - 1 šroub	34032R0202	32-3/4"	110
	34040R0202	40-3/4"	65
	34050R0202	50-3/4"	65
	34063R0202	63-3/4"	30



NOVÝ MODEL

Plastové svěrné spojky Plas-Fit – Unifit univerzální spojka na různé typy potrubí

Použití – trubky:	Plassim Unifit univerzální svěrný přechod na trubky z jiných materiálů (například PVC, olovo, měď, ocel) <ul style="list-style-type: none"> • d15 – 21, 21 – 27, 27 – 35 mm, PN 16 • Přestavbovou sadu je možno použít místo svěrného konce v rozměru 25, 32 a 40 mm Spojení je pevné díky svěrnému kroužku s hroty z nerezové oceli
--------------------------	--

	Objednací číslo	Rozměr v mm	Bal. v ks
	15015M5016	Unifit O 15–21 × 16	80
	15015M5020	Unifit O 15–21 × 20	70
	15015M5025	Unifit O 15–21 × 25	60
	15021M5020	Unifit O 21–27 × 20	54
	15021M5025	Unifit O 21–27 × 25	48
	15021M5032	Unifit O 21–27 × 32	36
	15027M5025	Unifit O 27–35 × 25	25
	15027M5032	Unifit O 27–35 × 32	22
	15027M5040	Unifit O 27–35 × 40	36

	15015Z5020	Unifit WO 15–21 × 20	55
	15015Z5025	Unifit WO 15–21 × 25	45
	15021Z5025	Unifit WO 21–27 × 25	1
	15021Z5032	Unifit WO 21–27 × 32	1
	15027Z5032	Unifit WO 27–35 × 32	1
	15027Z5040	Unifit WO 27–35 × 40	1

	Objednací číslo	Rozměr v mm	Bal. v ks
Unifit – sada	15015E5800	Unifit sada 15–21 × 25	50
	15021E5800	Unifit sada 21–27 × 32	40
	15027E5800	Unifit sada 27–35 × 40	30

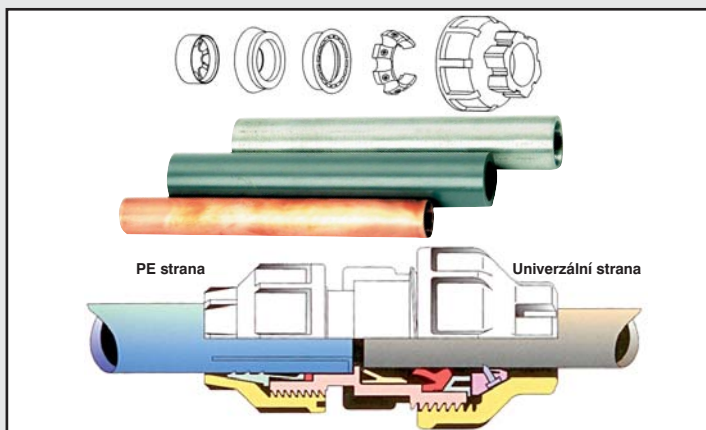



Náhradní díly Plas-Fit

	52016A0601	D kroužek 16	1
	52020A0601	D kroužek 20	1
	52025A0601	D kroužek 25	1
	52032A0601	D kroužek 32	1
	52040A0601	D kroužek 40	1
	52050A0601	D kroužek 50	1
	52063A0601	D kroužek 63	1
	52075A0601	D kroužek 75	1
	52090A0601	O kroužek 90	1
	52110A0601	O kroužek 110	1

	52075A3601	O kroužek 75	1
	52090A3601	O kroužek 90	1
	52110A3601	O kroužek 110	1

	15016H0610	Svěrný kroužek 16	1
	15020H0610	Svěrný kroužek 20	1
	15025H0610	Svěrný kroužek 25	1
	15032H0610	Svěrný kroužek 32	1
	15040H0610	Svěrný kroužek 40	1
	15050H0610	Svěrný kroužek 50	1
	15063H0610	Svěrný kroužek 63	1
	15075H0610	Svěrný kroužek 75	1
	15090H0610	Svěrný kroužek 90	1
	15110H0610	Svěrný kroužek 110	1

	35075H0610	O kroužek 75	1
	35090H0610	O kroužek 90	1
	35010H0610	O kroužek 110	1

	52025A0500	O kr. 25 – do navrt. 2	1
	52032A0500	O kr. 32 – do navrt. 2	1
	52040A0500	O kr. 40/50 – do navrt. 2	1
	52063A0500	O kr. 63/75 – do navrt. 2	1
	52-02A0032	O kr. 3/4" – do navrt. 4/6	1
	52-03A0032	O kr. 1" – do navrt. 4/6	1
	52-05A0063	O kr. 1 1/4" – do navrt. 4/6	1
	52-05A0075	O kr. 1 1/2" – do navrt. 4/6	1
	52-06A0075	O kr. 2" – do navrt. 4/6	1
	52-08A0160	O kr. 3" – do navrt. 4/6	1

	15016H0510	Matka 16	1
	15020H0510	Matka 20	1
	15025H0510	Matka 25	1
	15032H0510	Matka 32	1
	15040H0510	Matka 40	1
	15050H0510	Matka 50	1
	15063H0510	Matka 63	1
	15075H0510	Matka 75	1
	15090H0510	Matka 90	1
	15110H0510	Matka 110	1

	35075H0510	Matka 75	1
	35090H0510	Matka 90	1
	35010H0510	Matka 110	1

Telekomunikační spojky Plas-Fit Comfit push-fit spojky

Teplota	-15 až 60 °C
Tlak	12 bar, krátkodobě až 16 bar
Ostatní	vodotěsné a vzduchotěsné odolné proti UV záření odolné proti korozi a většině chemických látek

	Objednací číslo	Rozměr v mm	Bal. v ks
Comfit push-fit spojka 	40032M0032	32 x 32	70
	40040M0040	40 x 40	60
	40050M0050	50 x 50	33

	Objednací číslo	Rozměr v mm	Bal. v ks
Comfit push-fit spojka s vnějším závitem 	40032M0103	32 x 1"	70



Teplota	-20 až 80 °C
Ostatní	na ochranu proti vodě, prachu, nečistotám a cizím tělesům, vodotěsné odolné proti UV záření dobře rozeznatelné – červená barva určené pro vícenásobné použití

	Objednací číslo	Rozměr v mm	Bal. v ks
Slim comfit push-fit spojka 	*40032M3032	32 x 32	
	*40040M3040	40 x 40	
	40050M3050	50 x 50	
	* připravujeme		

	Objednací číslo	Rozměr v mm	Bal. v ks
Comfit Plug 	40032P0100	26 – 31	120
	40040P0100	31 – 39	90
	40050P0100	38 – 49	60
	40063P0100	47 – 62	35

Transfit

Teplota	-20 až +60 °C
Tlak	16 bar
Ostatní	vodotěsné a vzduchotěsné odolné proti UV záření odolné proti korozi a většině chemických látek

Transfit spojka 	Objednací číslo	Rozměr v mm	Bal. v ks
	15016M3016	16 x 16	75
	15020M3020	20 x 20	90
	15025M3025	25 x 25	60
	15032M3032	32 x 32	36
	15040M3040	40 x 40	36
	15050M3050	50 x 50	18
	15063M3063	63 x 63	11

Transfit zátka 	Objednací číslo	Rozměr v mm	Bal. v ks
	15020S3000	20	150
	15025S3000	25	150
	15032S3000	32	150
	15040S3000	40	150
	15050S3000	50	150
	15063S3000	63	150
	15075S3000	75	150
	15090S3000	90	150
	15110S3000	110	150

Transfit spojka redukováná 	Objednací číslo	Rozměr v mm	Bal. v ks
	15020D3016	20 x 16	50
	15025D3016	25 x 16	35
	15025D3020	25 x 20	70
	15032D3020	32 x 20	54
	15032D3025	32 x 25	48
	15040D3025	40 x 25	30
	15040D3032	40 x 32	22
	15050D3025	50 x 25	18
	15050D3032	50 x 32	25
	15050D3040	50 x 40	24
	15063D3032	63 x 32	15
	15063D3040	63 x 40	15
	15063D3050	63 x 50	12
	15075D3032	75 x 32	12
	15075D3040	75 x 40	12
	15075D3050	75 x 50	11
	15075D3063	75 x 63	8